

- <4W Input Power
- 1350 Lumen output
- To be operated with FHS1-UNV-3.6L only
- Wall Sconce and Ceiling Flush Mount compatible
- Low Level Lighting
- Linear arrays are linkable

## General Specifications

Universal Voltage *	120V - 277V ± 10%, 47-63Hz
Surge Protection	C62.41 (TVS)
Over Current Protection	Fuse
Input Current	0.07A
Input Power *	<4W
Lumen Output *	1350 Lumens
Maximum Output Current	3.5 Amp. when used with # FHSBATT3-F7L
Output Voltage	3.6V
Output Short Circuit Protection	Self resetting PTC
Recharge Time Required	24 Hrs.
Battery Type	NiCd 3.6VDC
Battery Capacity Available	7Ah
Illumination Time	Minimum 90 min
Estimated Run Time	120 Min.
Output Classification	UL 1310 / Class 2
Ambient Temperature	0°C - 50°C
Warranty	5 Years

## HotSpot UL Classified Kit components



**\*For further detailed instructions and list of kit components please refer to the Installation Instructions.**

\*Self-Diagnostic Standard.  
 \*Self-Diagnostic comes factory disabled.  
 Please reference pg.4 for more details.

#### Part Number Matrix

# FHS

Product Line  
FHS = HotSpot

# KIT

KIT

# T

Retrofit Type  
T = Troffer

# 10

LED Wattage  
.10 = 10W

# LN

LED Type  
LN = Linear

# F

Battery Type  
F = F Cell

# L

Case Type  
L = Long

#### Mechanical Data

##### FHS1-UNV-3.6L

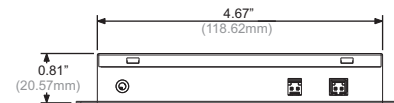
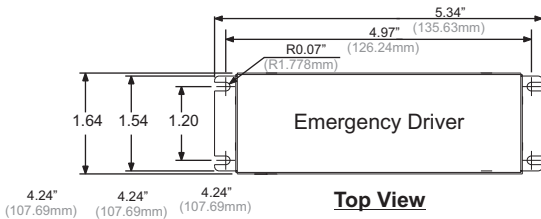

##### FHSBATT3-F7L

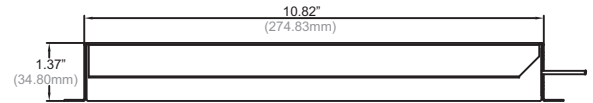
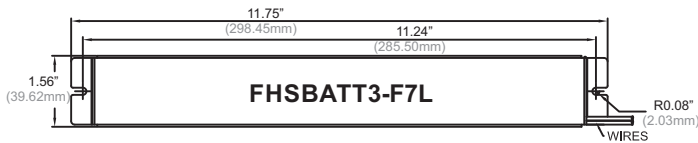

##### FHS6-AR-3W-L LINEAR MODULE

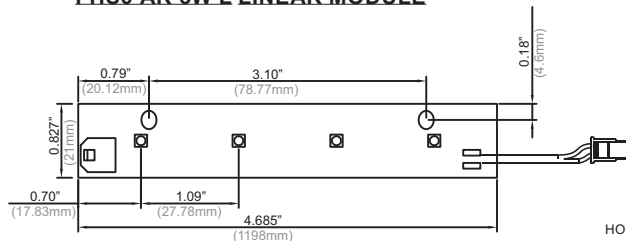

HOLES: 2 - 0.169" x 0.205" [4.3mm x 5.2mm]

### Wiring Diagram

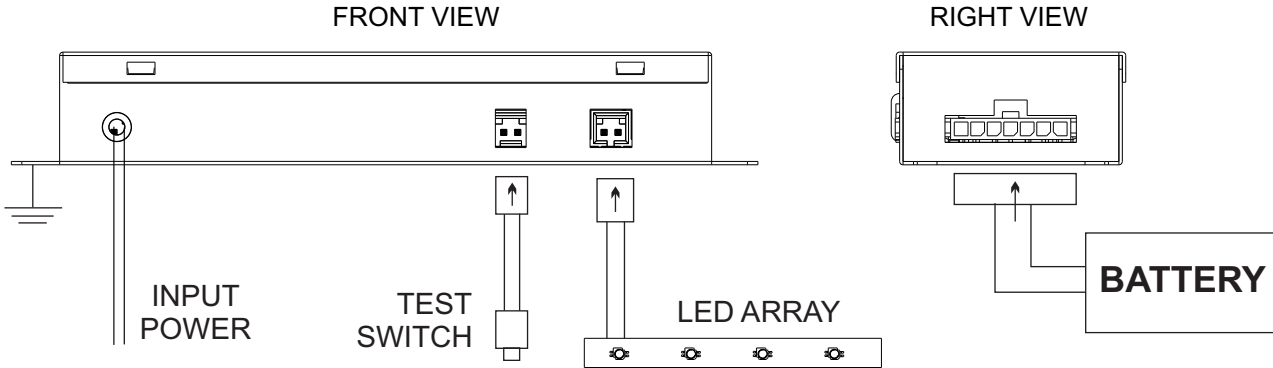

### WIRING DIAGRAM (TYP)

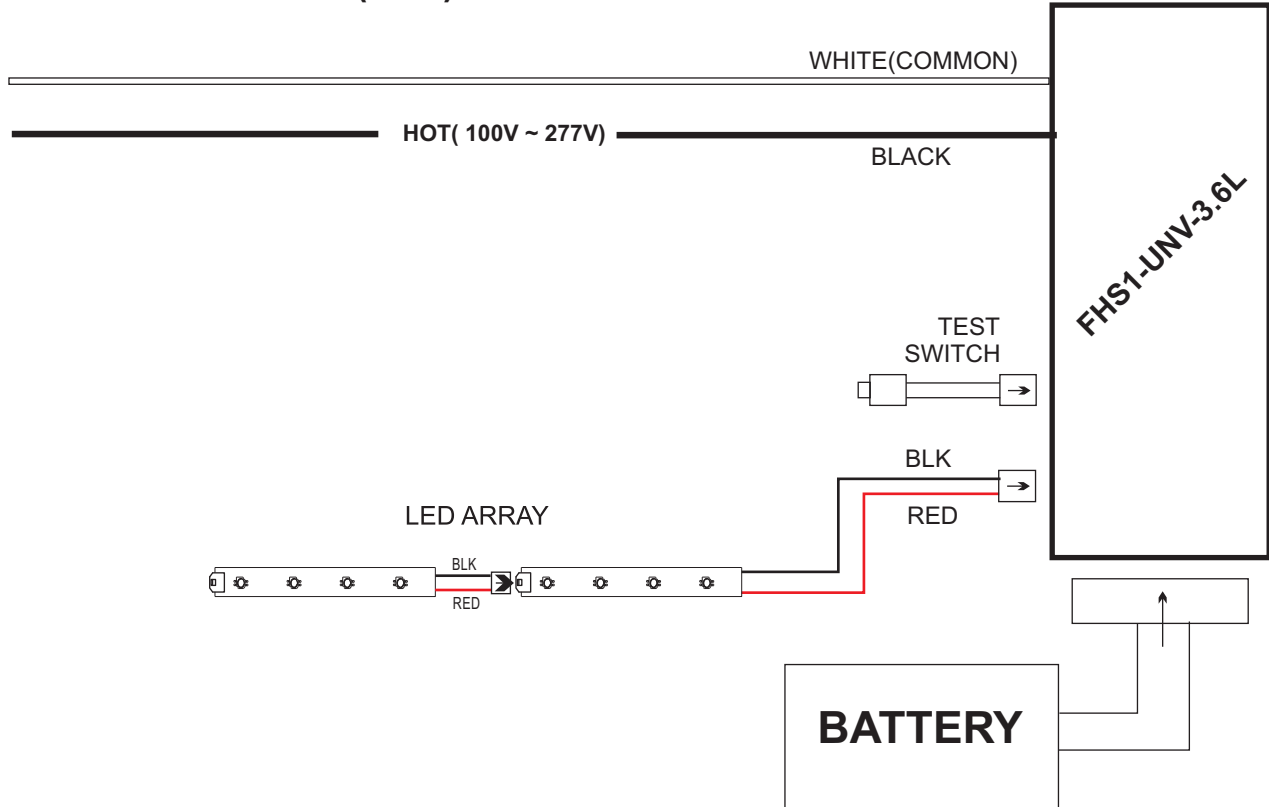

WIRE	BLACK	WHITE	BATTERY-LED ARRAY-TEST SWITCH-PILOT LIGHT
LENGTH - INCHES	12 ± 1"	12 ± 1"	24 ± 1"

**Test Switch Indicator Status**

<b>FHS1-UNV-3.6L Status Indication - Single Color Indicator</b>			
<b>LED indicator</b>	<b>Status</b>	<b>Comment</b>	<b>Note</b>
<b>Permanent Red Light/Solid</b>	<b>System OK</b>	<b>AC mode</b>	
<b>Blinking ON (4.5 sec on – 0.5 sec off)</b>	<b>Self-diagnose test underway</b>	<b>Self-Diagnostic</b>	
<b>Blinking OFF (0.5 sec on – 4.5 sec off)</b>	<b>Charge circuit is broken</b>	<b>Replace EM Driver</b>	
<b>Fast Flashing (0.5 sec on - 0.5 sec off)</b>	<b>Battery not connected</b>	<b>Connect battery pack.</b>	
<b>Fast Flashing (0.5 sec on - 0.5 sec off)</b>	<b>Battery failure</b>	<b>Change the battery</b>	
<b>Very Slow Flashing (4 sec on – 4 sec off)</b>	<b>Over Circuit Protection Error Triggered.</b>	<b>Check LED load or check EM driver.</b>	<b>AC power will need to be cycled on/off as well as the battery re-connected</b>

**TEST SWITCH OPERATIONS:**

1. EM TEST : Press and hold test button for more than one second to enter EM mode for testing.
2. Manual Self-Diagnostic : After charging the battery for the specified recharge time, quickly press the test button three times within two seconds to force the controller to enter a Self-Diagnostic cycle. To quit the self-diagnostic cycle after engaged press and hold the test button for ten seconds.
3. Enable/Disable Self-Diagnostic Status : Quickly press the test button two times within two seconds ,the monochromatic lamp displays the status of Self-Diagnostic Enable / Disabled settings.
4. Enable/Disable Auto Self-Diagnostic : Press and hold the test button for two seconds, then release and quickly press the test button two times, then release and press and hold the test button for two more seconds. When properly executed the indicator on the test button will display the flash mode for the Enable/Disable status. A flash of 2.5S on - 0.5S off means "Enabled", while a flash of 0.5S on - 2.5S off means "Disabled", the flashing will last for a few cycles.

**SELF- DIAGNOSTIC INSTRUCTIONS / OPERATION:**

**If the self-diagnostic feature is enabled:**

The emergency LED driver will conduct a self-check for thirty (30) seconds every thirty (30) days; and a ninety (90) minute self-check every 12 months. After every self-check the LED indicator light will indicate a status signal. Check indicator status chart above to diagnose the status signal.

**If the self-diagnostic feature is disabled:**

User must conduct a manual test every thirty (30) days to ensure the emergency LED light source illuminates as intended. A full discharge test shall be conducted once a year; the LED light source shall illuminate for a minimum of ninety (90) minutes.

**\*Self-Diagnostic feature is factory disabled**