

700mA Programmable LED Driver

- Class 2, 20W constant current output with 0-10V dimming
- Full featured programmability with 12Vdc 100mA auxiliary output
- Low standby power (<0.5W) in dim-to-off state



Performance

Input Voltage	120 ~ 277 Vac
Input Current Max	0.19A / 120V 0.09A / 277V
Input Power Max	24W
Input Frequency	50 - 60 (Hz)
Power Factor	> 0.95 @ max load
THD max	< 20 % @ max load
Output Voltage	16V to 29V @ 0.70 Amps (Refer to Driver Operating Range) 16V to 56V @ 0.36 Amps
Max. Output Current	700mA
Min. Dimming Current	4mA
Output Power	20W
Standby Power	< 0.5W @ 120Vac < 0.5W @ 277Vac
Line Regulation	±3 %
Load Regulation	±5 %
Output Current Ripple	<10% (Pk-Pk/avg)
Inrush Current*	120V: 18A / 314uS Peak / >10% Duration 277V: 42A / 287uS

* source impedance per NEMA 410

Auxiliary Output

Output Power	1.2W
Output Voltage	12Vdc
Output Current	100 mA

Physical

Length	14.25 in
Width	1.18 in
Height	1.00 in
Mounting Length	13.75 in
Weight (lbs)	1.00 lbs

Wire Trap / Plug-in Connectors: Strip length 0.33 in
Use 16-22 AWG Solid Wire rated ≥ 90°C 300V

Environmental

EMI and RFI	Meets FCC part 15 (Class A) Non-Consumer Limits
Sound Rating	Class A
Operating Temperature	-40°C to 50°C (-40°F to 122°F)
Storage Temperature	-40°C to 85°C (-40°F to 185°F)
Warranty Tc	85°C max for 50k Hr Life
Location Rating	UL Dry & Damp
Transient Protection	IEEE C62.41 2.5kV

Wiring Diagram:

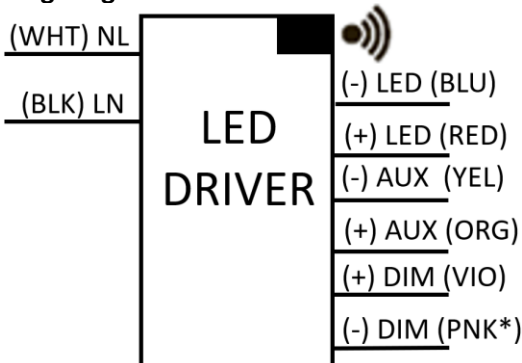

* **Note:** The Gray has been changed to Pink for the negative 0-10V dimming control lead.

Protection

Over Voltage, Under Voltage, Short Circuit, Over Temp

Safety:

UL 8750 & CSA 250.13
UL Class P



Ordering Information

Order Number	Description	Qty/Carton
D700C20UNVPWX12-C010C	700mA 20W	10

Application and operation performance specification information subject to change without notification.

Programmable Features
Output Current
Minimum Dimming Level
Dim-to-Off
Dimming Curve (Linear, Linear Soft Start, Logarithmic)
Lumen Maintenance

Programming System	
Software	EVERset Programming Software
Hardware	LDPC000A Configuration Tool
Driver Interface	Wireless via RFID

*Refer to application notes EVD10 and EVD11 at www.unvlt.com for additional information on programmable features.

Driver Operating Range:

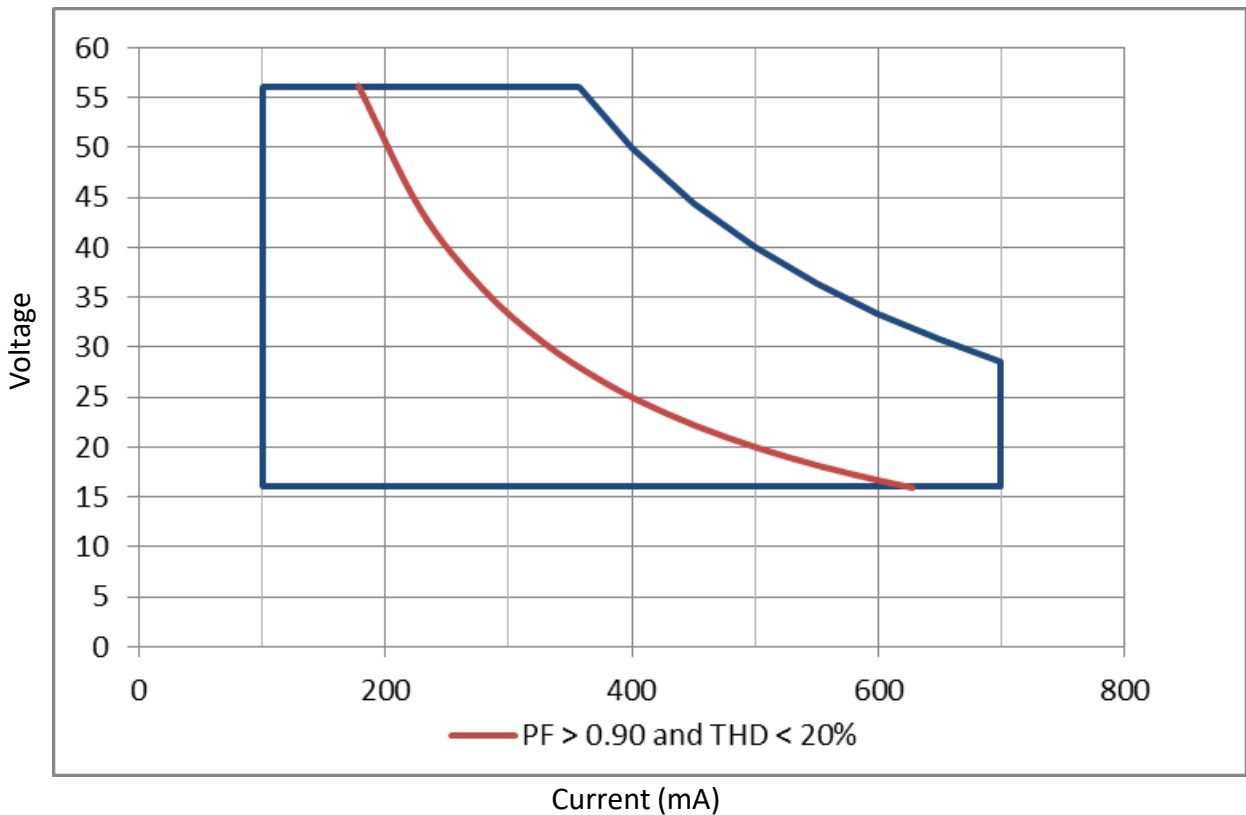

Application and operation performance specification information subject to change without notification.

0-10V Dimming

Linear Dimming w/ Dim-to-Off

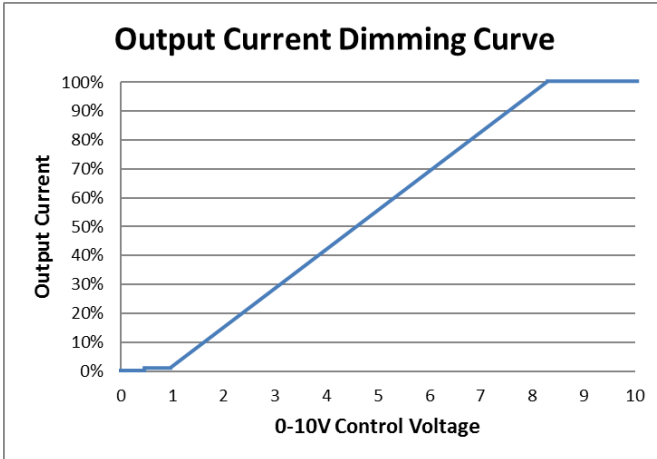

Linear Dimming to 1%*

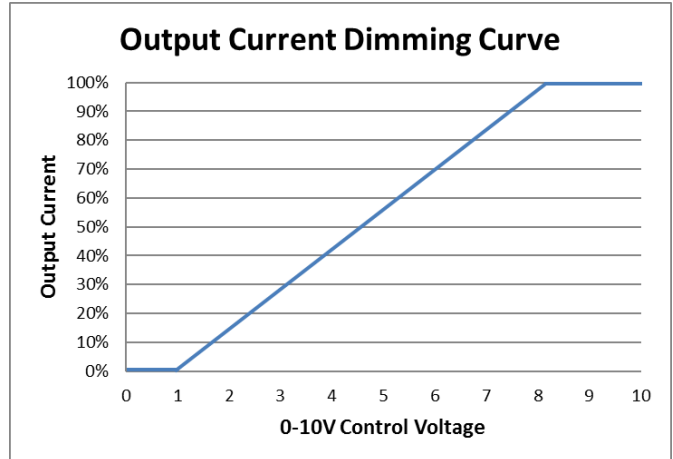

0-10V Analog Dimming Interface

- Analog 0 to 10 Vdc Voltage Control
- Use Violet (+) & Pink* (-) for connection to 0-10 Vdc.
- 10V = maximum output
- 0V = dim-to-off or programmed minimum dimming level
- 0-10V interface can be wired as Class 1 or Class 2 Circuit.
- Driver will source a maximum of 165uA for control needs.
- Controller must sink current from the 0-10V control leads.

* Driver ships with Dim-to-Off enabled. Dim-to-Off can be disabled through the EVERset programming software.

Programmable Dimming Features

Feature	Range	Factory Default
Maximum Output Current	100 - 700mA	default = 700mA
Minimum Dimming Level	4 - 350mA	default = 4mA
Dimming Curve	(Linear, Linear Soft Start, Logarithmic w/ factor 1 to 7)	default = Linear
Dimming Control Voltage Range		
Max Bright Control Voltage	7 - 9Vdc	default = 8Vdc
Min Dim Level Control Voltage	1 - 3Vdc	default = 1Vdc
Dim-to-Off	0.1 - 1.7Vdc; 0 = disabled	default = 0.5Vdc (enabled)

* Refer to application note EVD10 at www.unvlt.com for additional information on programmable dimming features.

Application and operation performance specification information subject to change without notification.

Performance: Efficiency

Typical performance measurements are shown. The charts are to be used as a guideline and not for specification use.

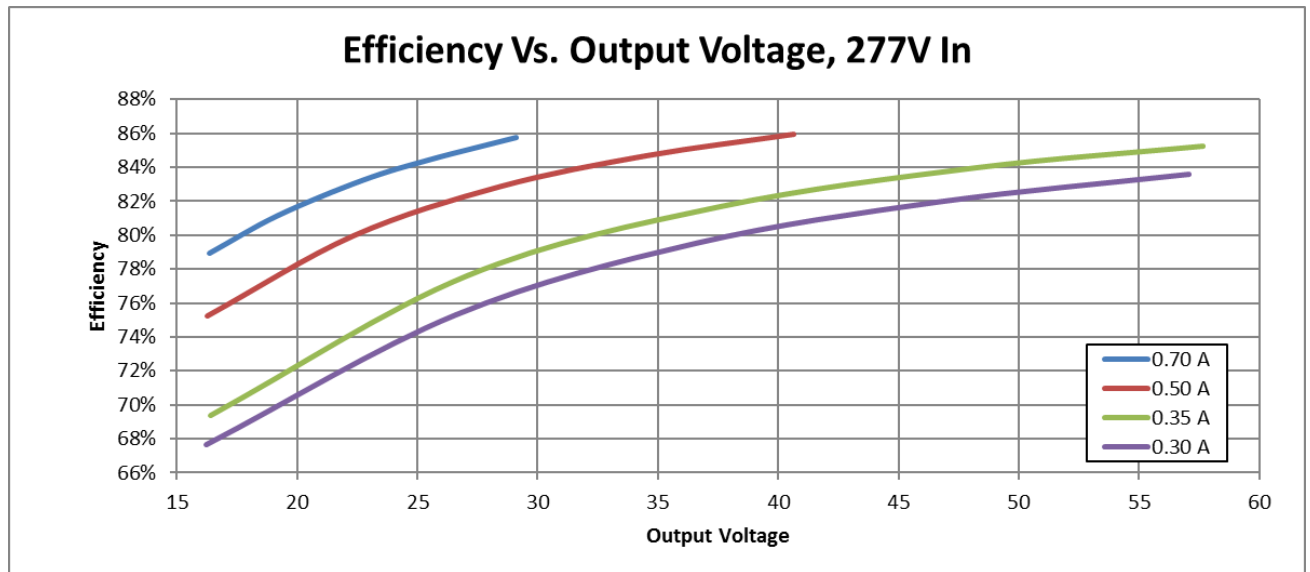
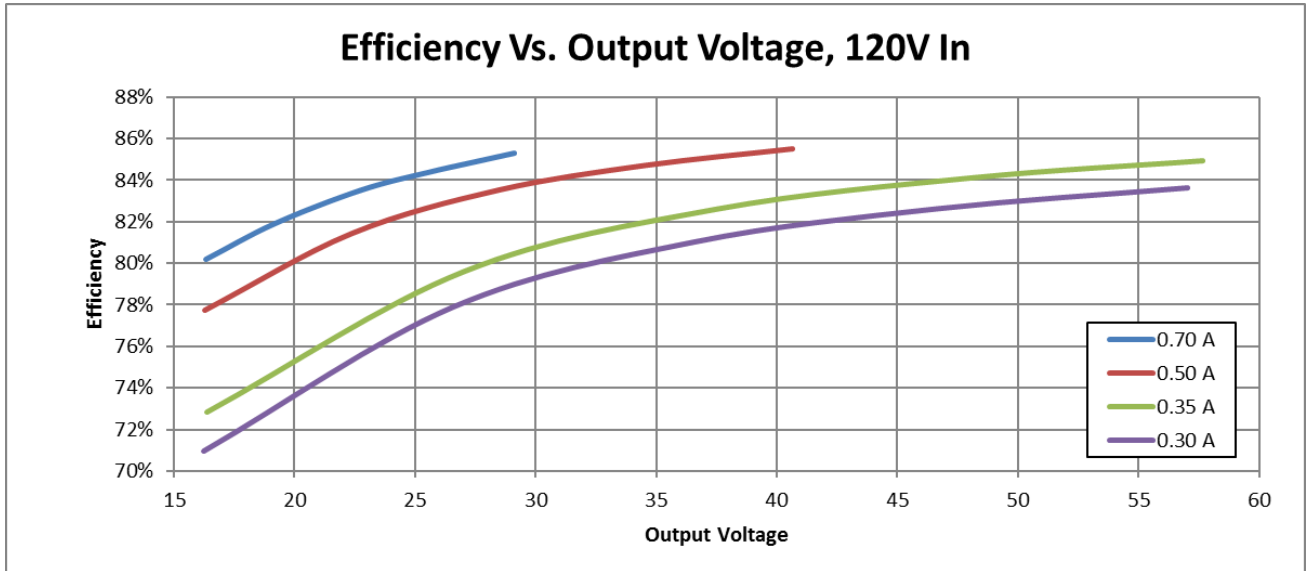

Application and operation performance specification information subject to change without notification.

Performance: Total Harmonic Distortion, & Power Factor

Typical performance measurements are shown. The charts are to be used as a guideline and not for specification use.

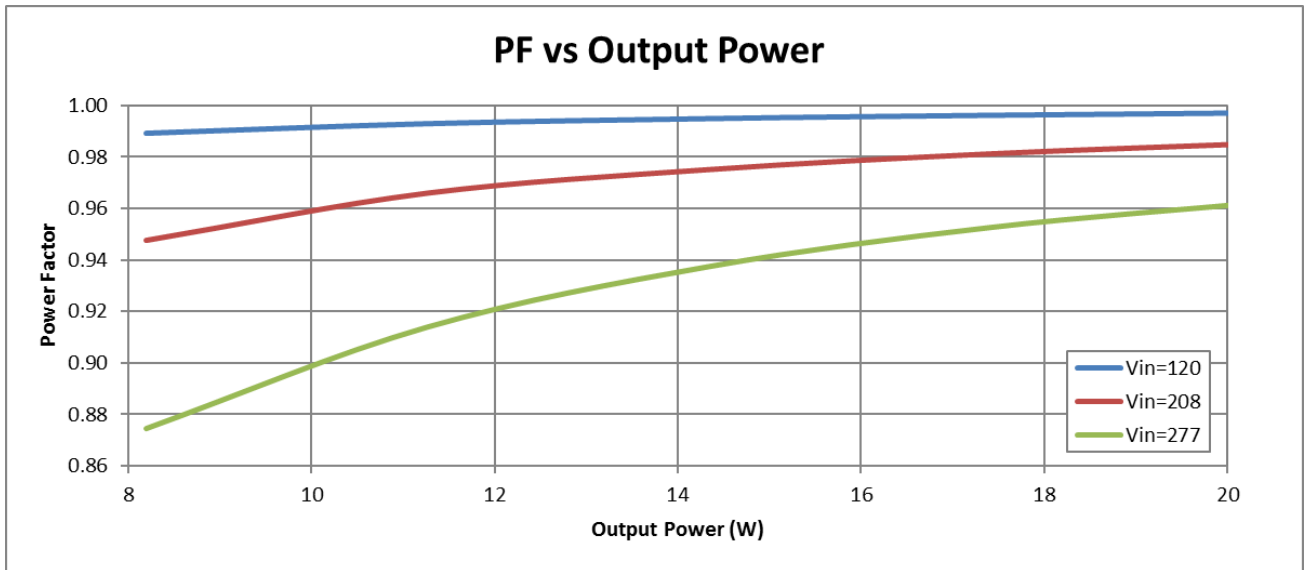
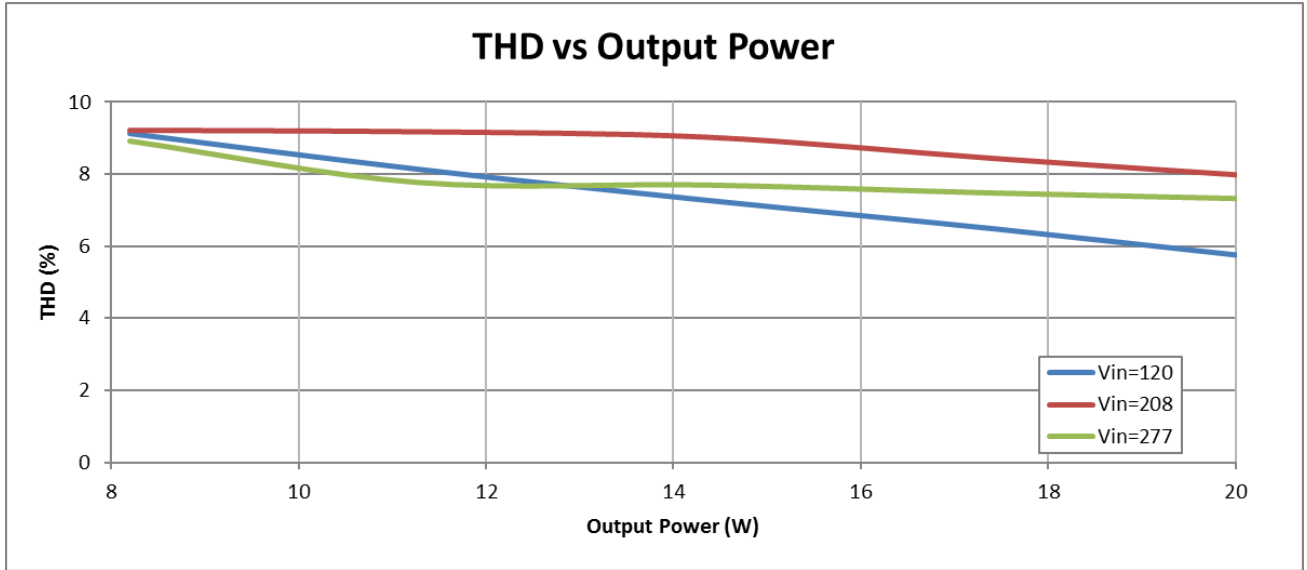

Output power based on maximum rated output current and varying load voltages.

Application and operation performance specification information subject to change without notification.

Dimensional Diagram:

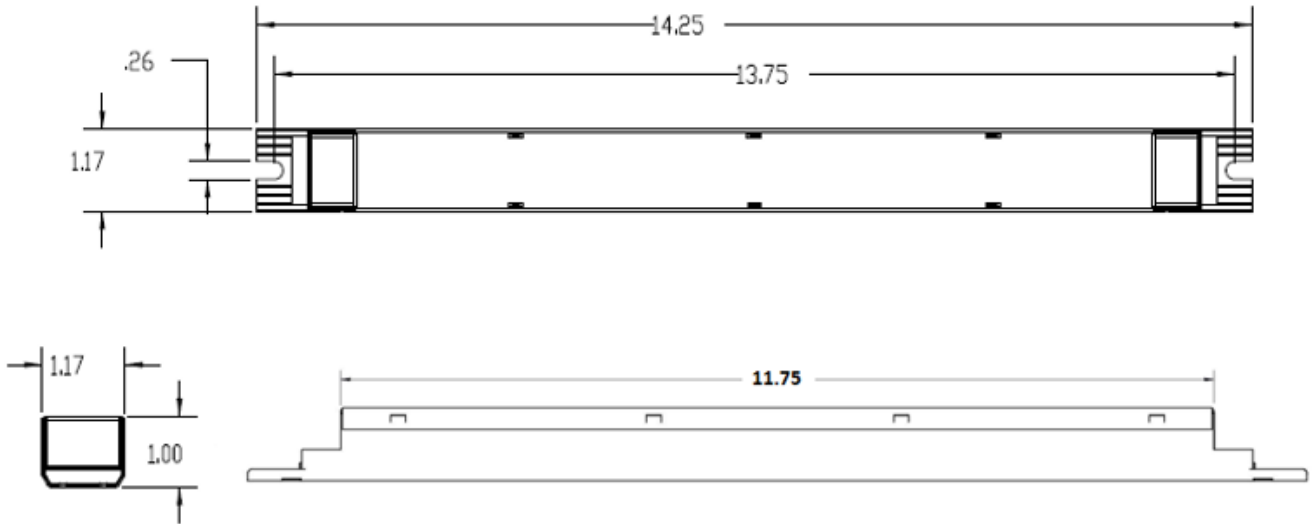

Tc Location:

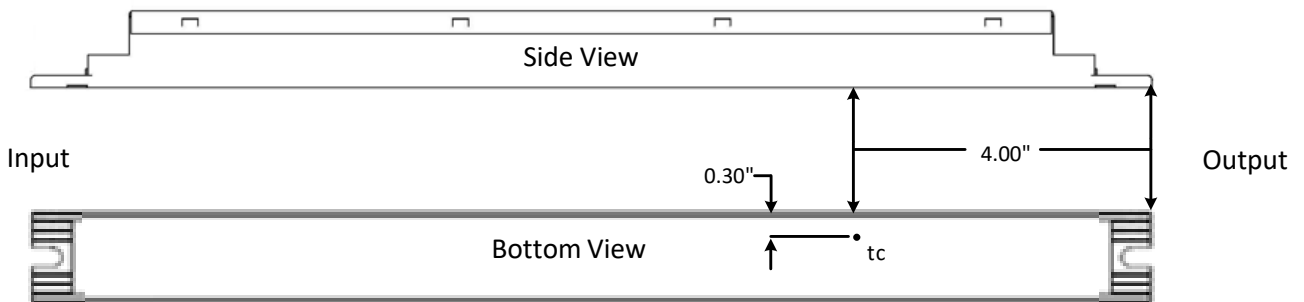

Application and operation performance specification information subject to change without notification.

Transient Protection		
Transient	Differential Mode (L-N)	Common Mode (L-G, N-G, L&N-G)
IEEE C62.41 100kHz Ring Wave (200A maximum)	> 2.5kV	> 2.5kV

Isolation					
Isolation	Input	Output	0-10V	Auxiliary	Enclosure
Input	-	2xU + 1kV	2xU + 1kV	2xU + 1kV	2xU + 1kV
Output	2xU + 1kV	-	2xU + 1kV	Non-Isolated	700V
0-10V	2xU + 1kV	2xU + 1kV	-	2xU + 1kV	2xU + 1kV
Auxiliary	2xU + 1kV	Non-Isolated	2xU + 1kV	-	700V
Enclosure	2xU + 1kV	700V	2xU + 1kV	700V	-

U = Max Input Voltage

FCC Statement: This device complies with part 15 of the FCC Rules. Operation is subject to the following two conditions: (1) This device may not cause harmful interference, and (2) this device must accept any interference received, including interference that may cause undesired operation.

Warranty:

Universal Lighting Technologies warrants to the purchaser that each power supply will be free from defects in material or workmanship for a period of 5 years from the date of manufacture when properly installed per instructions and under normal operating conditions of use. Call 1-800-225-5278 for technical assistance.

Application and operation performance specification information subject to change without notification.