

2300mA LED Driver w/ Constant Power Tuning

- Universal (120-277V) Input Voltage
- Class 2, 90W Constant Current Output
- 0-10V Dimming Control to 10%



Performance	
Input Voltage	120 ~ 277 Vac
Input Current Max	0.88 /120V 0.38/277V
Input Power Max	105W
Input Frequency	50 - 60 (Hz)
Power Factor	> 0.95
THD max	< 20 %
Output Voltage	18V to 39V @ 2.30 Amps (Refer to Power Curve Chart) 18V to 45V @ 2.00 Amps
Max. Output Current	2300mA
Min. Dimming Current	230mA
Output Power	90W
Line Regulation	±3 %
Load Regulation	±5 %
Output Current Ripple	<10%
Inrush Current	120V: 25A / 230uS
Peak / >50% Duration	277V: 54A / 85uS

- * Refer to charts for additional information
- Harmonic Emissions comply with ANSI C82.77
- Inrush current complies with NEMA 410

Wiring Diagram:

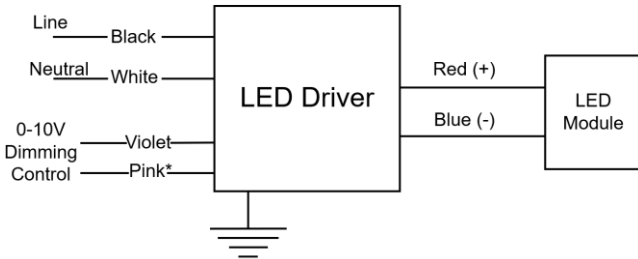

- * **Note:** The Gray has been changed to Pink for the negative 0-10V dimming control lead.



Physical	
Length	9.50 in (241.3 mm)
Width	2.40 in (61.0 mm)
Height	1.55 in (39.4 mm)
Mounting Length	8.89 in (225.8 mm)
Weight (lbs)	2.6
Lead Lengths	
Black, White	11.5 in
Red(+), Blue(-), Pnk, Vio	11.5 in

Lead-wires are 18 AWG 90°C /600V solid copper.

Protection

Over voltage, Under voltage, over temp. and short circuit.

Safety:

UL 8750 & CSA 250.13, UL Class P

Ordering Information

Order Number	Description	Qty/Carton
D23CC90UNVTW-F20KC	Standard Product	10

*Consult Factory for Tuning ordering information

Environmental	
EMI and RFI	Meets FCC part 15 (Class A) Non-Consumer Limits
Operating Temperature	-40°C to 55°C
Storage Temperature	-40°C to 85°C
tc	85°C max for warranty 90°C max for UL
Location Rating	UL Dry & Damp, Type HL
IP Rating	IP66
Transient Protection	IEEE C62.41 6kV**

**Driver uses MOVs for transient protection.

Refer to application note EVD07 at www.unvlt.com for additional information on Hi-Pot Testing.

Application and operation performance specification information subject to change without notification.

Programmable Tuned Output Settings

- This Everline LED Driver can be configured to set its current output to a selected fraction of their maximum rated design level. This function is called tuning (or also high-end trim) and it can be implemented with the LDTC01A using the Selector rotary switches. Tuning assignments are stored in driver memory and are not lost when power is removed. All factory produced drivers are tuned to maximum output unless otherwise noted on the label.
- Tuning SET Levels are listed in the table to the right. The SET Level corresponds to an associated Output Current value.
- Refer to application note EVD06 at www.unvlt.com for additional information.
- Actual tuned output current values will be within +/- 3% of current listed in the table

Set Value	Output Current (A)
100	2.30
99	2.27
98	2.22
97	2.19
96	2.15
95	2.11
94	2.08
93	2.04
92	2.02
91	1.98
90	1.94
89	1.92
88	1.89
87	1.85
86	1.82
85	1.79
84	1.76
83	1.74
82	1.70
81	1.68
80	1.65
79	1.62
78	1.60
77	1.56
76	1.54

Set Value	Output Current (A)
75	1.52
74	1.49
73	1.46
72	1.44
71	1.41
70	1.39
69	1.37
68	1.35
67	1.32
66	1.29
65	1.27
64	1.24
63	1.22
62	1.19
61	1.18
60	1.15
59	1.12
58	1.11
57	1.08
56	1.06
55	1.03
54	1.02
53	0.99
52	0.97
51	0.94

Set Value	Output Current (A)
50	0.92
49	0.90
48	0.87
47	0.85
46	0.83
45	0.81
44	0.78
43	0.76
42	0.74
41	0.71
40	0.68
39	0.66
38	0.64
37	0.63
36	0.61
35	0.59
34	0.56
33	0.55
32	0.53
31	0.51
30	0.48
29	0.47
28	0.44
27	0.43
26	0.41
25	0.40

Driver Operating Range:

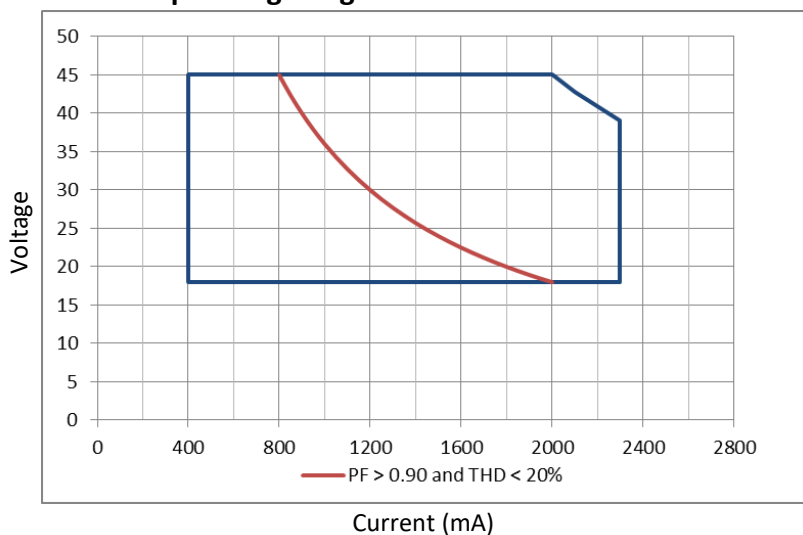

Application and operation performance specification information subject to change without notification.

0-10V Dimming

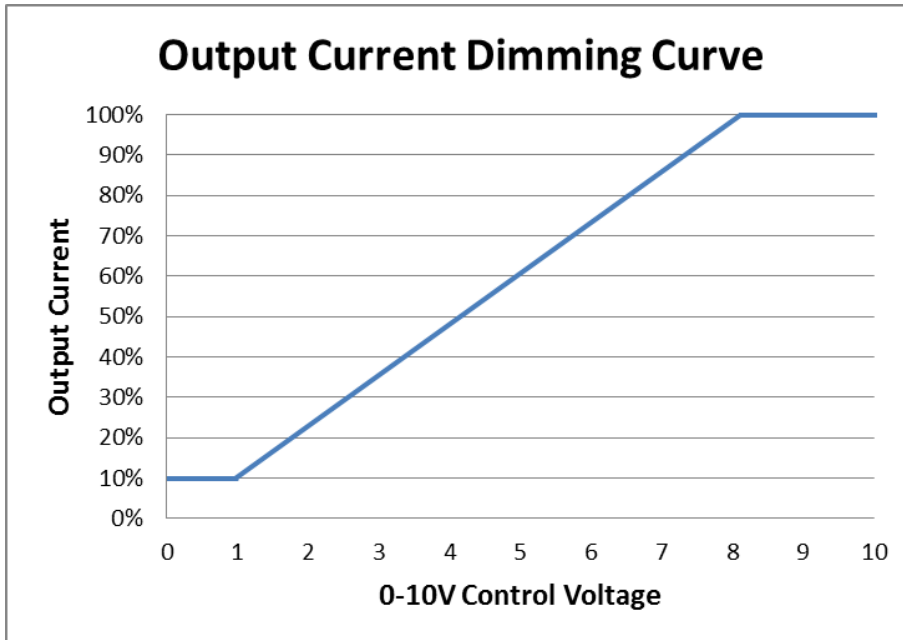

0-10V Analog Dimming Interface

- Analog 0 to 10Vdc Voltage Control
- Use Violet (+) & Pink* (-) for connection to 0-10Vdc.
- 10V = maximum output, 0V = minimum output
- Driver protected if line voltage is applied.
- Wiring Violet & Pink* together provides min. light output.
- Capping Violet & Pink* separately provides 100% light output.
- 0-10V interface can be wired as Class 1 or Class 2 Circuit.
- Driver will source a maximum of 250uA for control needs.

Application and operation performance specification information subject to change without notification.

Performance: Efficiency

Typical performance measurements are shown. The charts are to be used as a guideline and not for specification use.

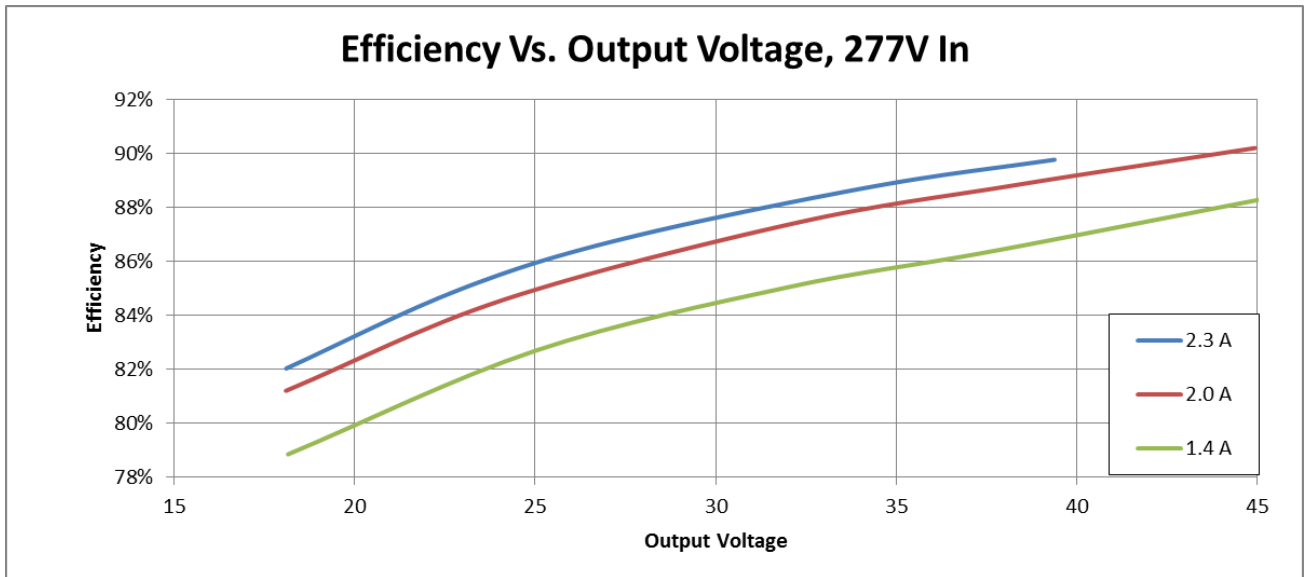
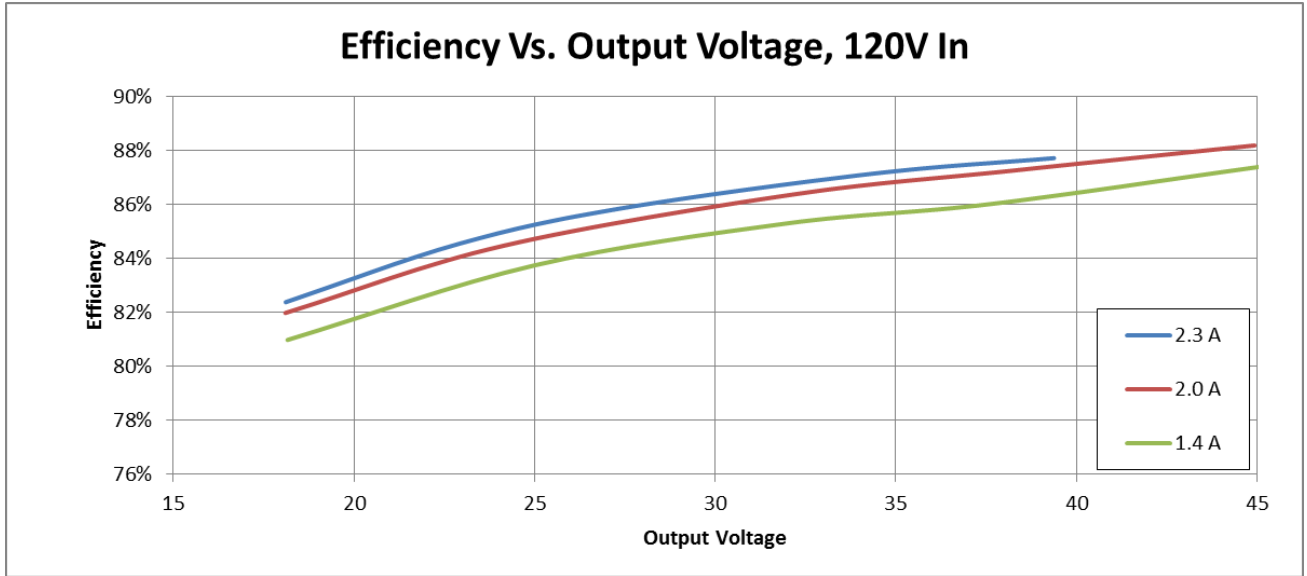

Application and operation performance specification information subject to change without notification.

Performance: Total Harmonic Distortion, & Power Factor

Typical performance measurements are shown. The charts are to be used as a guideline and not for specification use.

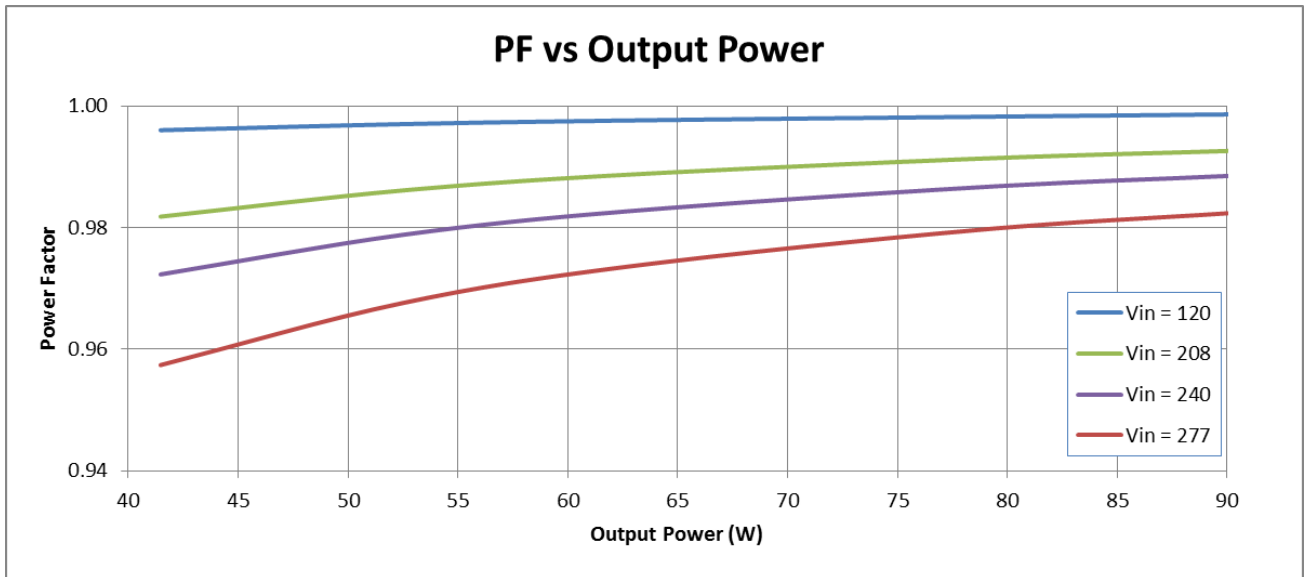
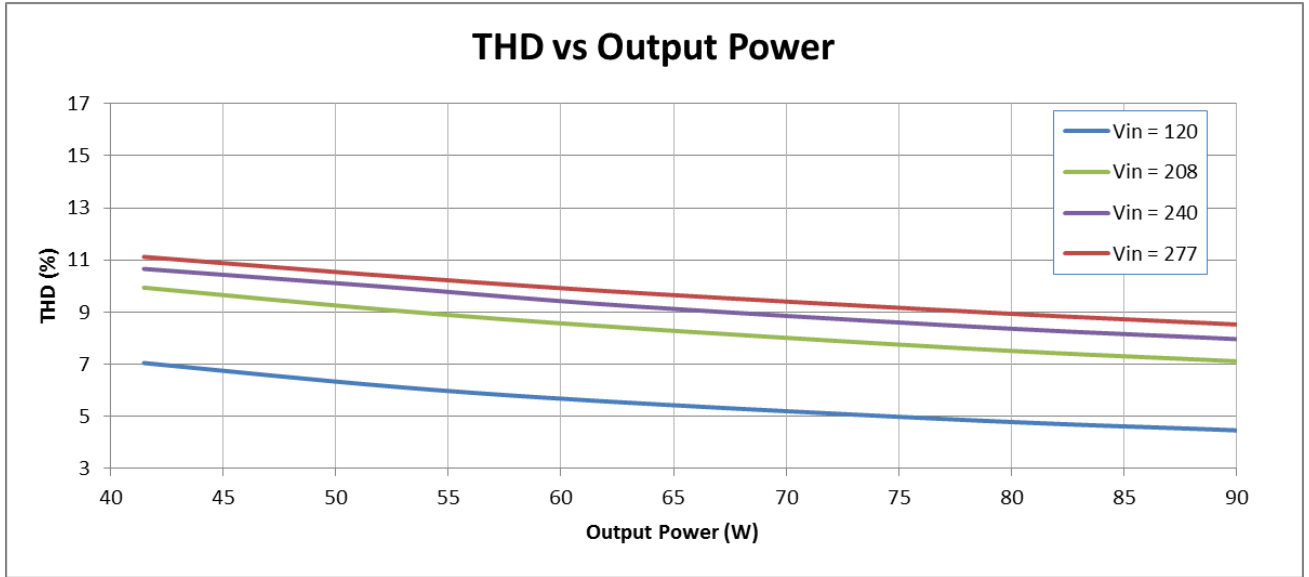

Output power based on maximum rated output current and varying load voltages.

Application and operation performance specification information subject to change without notification.

Transient Protection		
Transient	Differential Mode (L-N)	Common Mode (L-G, N-G, L&N-G)
IEEE C62.41 1.2/50µs Combination Wave (w/t 2Ω)	> 6kV	> 6kV

Isolation				
Isolation	Input	Output	0-10V	Enclosure
Input	-	2xU + 1kV	2xU + 1kV	2xU + 1kV
Output	2xU + 1kV	-	2xU + 1kV	2xU + 1kV
0-10V	2xU + 1kV	2xU + 1kV	-	2xU + 1kV
Enclosure	2xU + 1kV	2xU + 1kV	2xU + 1kV	-

U = Max Input Voltage

Driver Lifetime vs. Driver Case Temperature

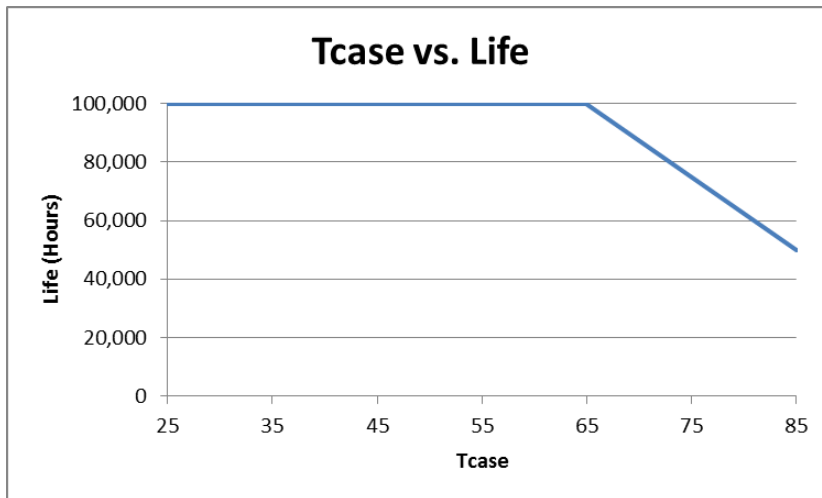

The Data curve provided predicts the LED Driver life based on the case temperature measured at the Tc location identified on the label or specification sheet. The Telecordia SR-332 standard is used to generate the prediction curves.

Application and operation performance specification information subject to change without notification.

Dimensional Diagram

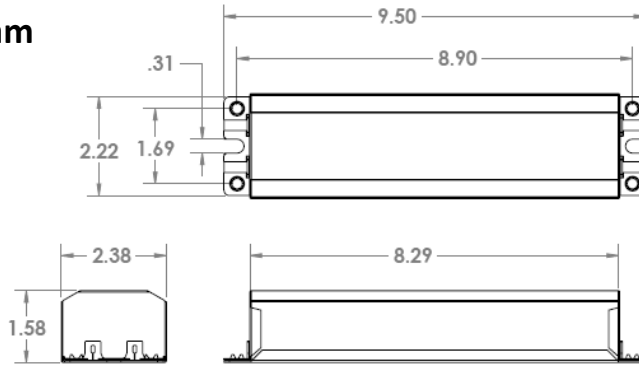

Tc Location

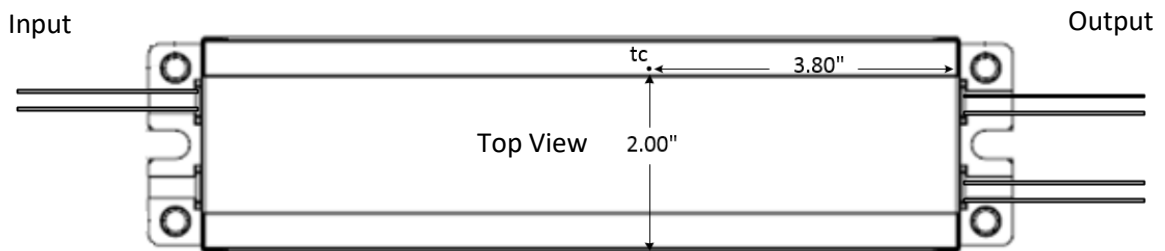

FCC Statement: This device complies with part 15 of the FCC Rules. Operation is subject to the following two conditions: (1) This device may not cause harmful interference, and (2) this device must accept any interference received, including interference that may cause undesired operation.

Warranty:

Universal Lighting Technologies warrants to the purchaser that each power supply will be free from defects in material or workmanship for a period of 5 years from the date of manufacture when properly installed per instructions and under normal operating conditions of use. Call 1-800-225-5278 for technical assistance.

Application and operation performance specification information subject to change without notification.