



IHCV-1UNV024V-100L



Constant Voltage LED Driver

- Input Voltage:110-277V~, 50/60Hz
- Output Current:4.1A
- Output Voltage:24V---
- Output Power:100W Max.
- U-OUT:25V ---
- Class P

General Specifications

Input Voltage / Frequency	110-277V~, 50/60Hz(NA), 110-240V~, 50/60Hz
Input Current	1.1A@110V, 0.44A@277V
Input Power	113W
Input PF	>0.95@110V 60%-100% Load, >0.9@277V 60%-100% Load
THD	<20%@110V-277V 60%-100% Load
Efficiency	88%@110V Full Load, 90%@277V Full Load
Inrush Current	<65A @110V, <90A @277V
Max Leakage Current	<0.7mA @240V per CE / <0.75mA@277V per UL
Output Voltage Range	24V---
Output Current	4.1A
Line Regulation / Load Regulation	<1% @100% Load / <3% @Full Load
Total Overall Ripple	<5% @Full Load
Low Frequency Ripple (120Hz ripple peak to peak)	<5% @Full Load
Flicker Percentage	<5%
Dimming Isolation	NA
Operating Ambient Temperature Range	-40°C to 50°C (-40°F to 122°F)
Maximum Driver Case Temperature (Tc) (Per UL)	81°C (177.8°F)
Start-up Time	<1000ms
Standby Power	NA
Driver Output Type / Number of Output Channels	Constant Voltage - LED Class 2 / 1 Channel
Overall Size	9.49" L x 1.69" W x 0.96" H (241mm L x 43mm W x 24mm H)
Wire Type / Length	18AWG / 11.8"
Weight	500g / 1.1lbs.
Safety / Compliance	EN61347-1, EN61347-2-13, UL8750,1310, UL879 cULus Listed Class P RoHS Compliant CE Suitable for Dry and Damp locations
IP Rating	IP64
Withstand Voltage	I/P-O/P:3000VAC, I/P-FG:1750VAC O/P-FG:500VAC
Insulation Resistance	I/P-O/P, I/P-FG, O/P-FG:100M Ohms/ 500VDC/25°C/70%RH
Potting Type / Degree of Fill	Potting As Per ASTM D36-86
EMC Emission	FCC Part 15B Consumer, EN55015,EN61000-3-2, 3
EMC Immunity	IEC61000-4-2,3,4,5,6,8,11,IEC61547
Operating Humidity	20-98% RH Non-condensing
Protections	Input Surge Line-Neutral 2KV, Line & Neutral-Ground 4KV(Ringwave 2.5KV / 2.5KV) Input Current Protection Output Short Circuit Protection(Recovers automatically after short is removed) Overload Protection Over Temperature Protection
Hot Swappable	No
Sound Rating	A
Service Life	50,000 hours lifetime @ Tc 86.9°C (188.42°F), see figure 4
Warranty	5 years @ Tc 86.9°C (188.42°F) from the date of manufacture

*FG = Fault Ground **I/P = Input Power ***O/P = Output Power



IHCV-1UNV024V-100L



Typical Characteristics Graphs: Input

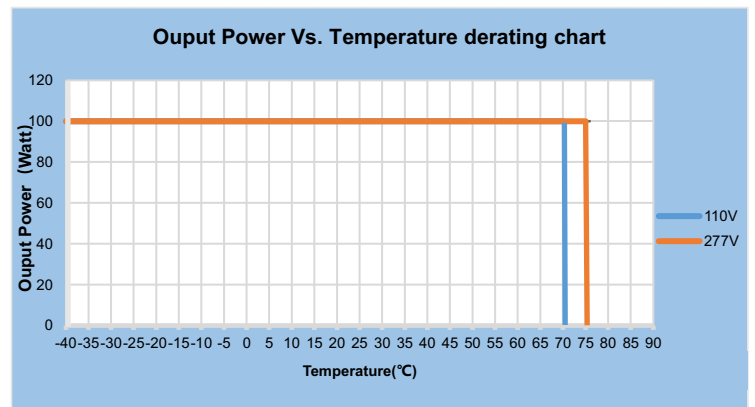
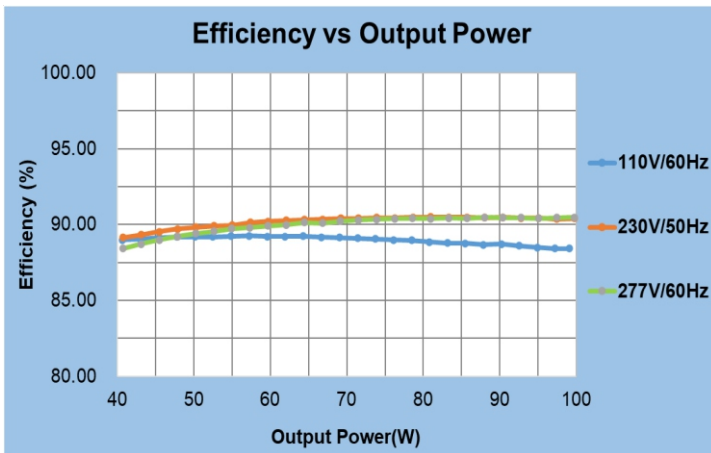
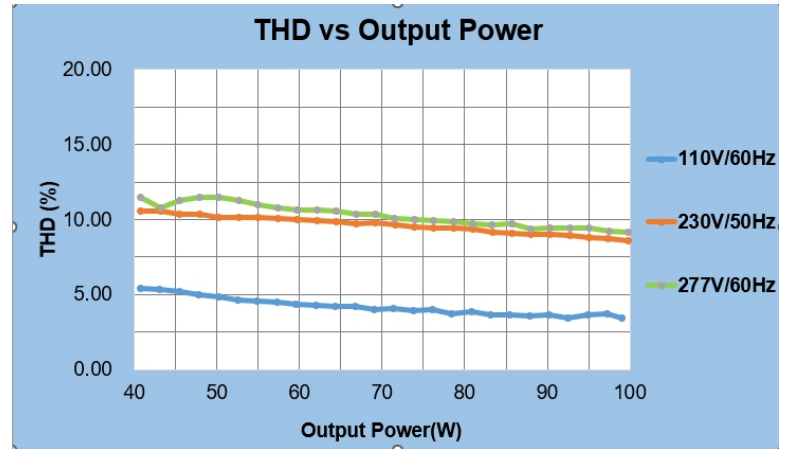
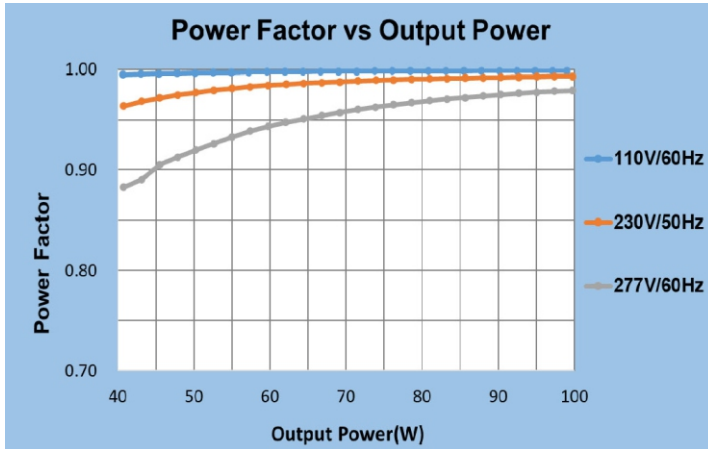



IHCV-1UNV024V-100L

SELV IP64



UL LISTED E342838



CE

RoHS COMPLIANT

UL E349510

MECHANICAL DATA

IHCV-1UNV024V-100L

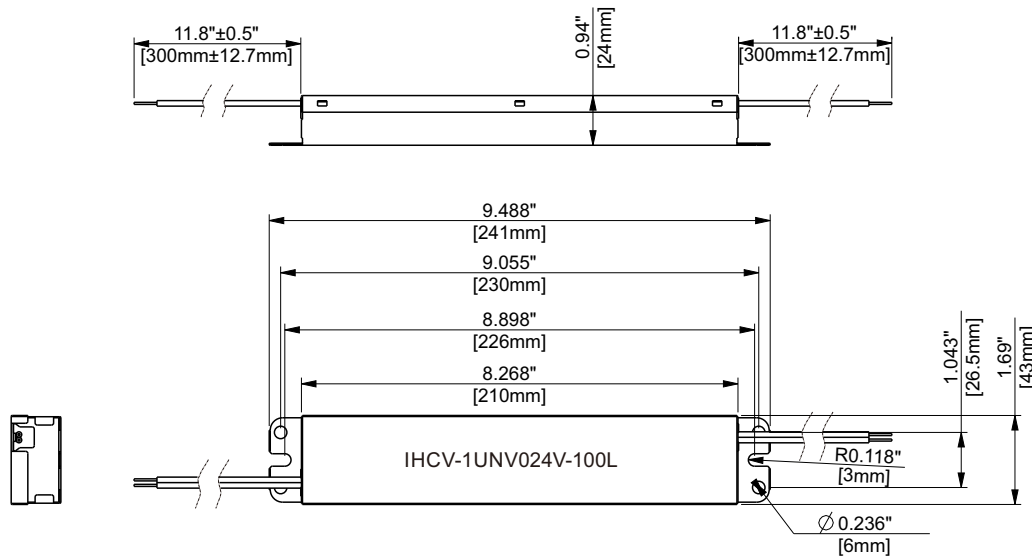

Overall Dimensions	
Length	9.49 " [241mm]
Width	1.69" [43mm]
Height	0.96" [24mm]
Wire Length	
AC Input (White/Black)	11.8" [300mm]
LED Output (Red/Blue)	11.8" [300mm]

Case Tolerance=±0.02" [±0.5mm]

Tolerance=0.02"



IHCV-1UNV024V-100L

SELV IP64



WIRING DIAGRAMS

IHCV-1UNV024V-100L

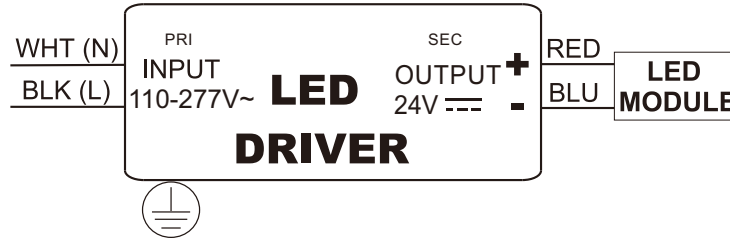

TOP VIEW

INPUT SIDE	LENGTH	OUTPUT SIDE	LENGTH
BLACK	11.8"[300mm]	RED	11.8"[300mm]
WHITE	11.8"[300mm]	BLUE	11.8"[300mm]

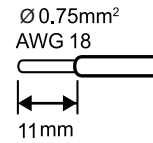



IHCV-1UNV024V-100L



Guidelines

Grounding

- Driver must be grounded by means of the Driver case.

Over temperature protection

- The Fulham IceHorse LED drivers is protected against thermal overload. If the temperature limit is exceeded, the output current shut down.

LED load

- Fulham PonyLED drivers are designed to drive passive LEDs, -COB's and -LED assemblies .Proper function is not guaranteed when (LED)loads with active components are used.

Short-circuit protection

- In case of a short circuit the LED driver switches to protection mode. After the removal of the short-circuit the LED driver will recover automatically.

No-load Operation

- In no-load operation the output voltage will not exceed the specified open circuit output voltage.

Hot Swapping

- This driver does not support hot swapping of the LEDs.

Remote Mounting

- Up to 50ft with 18AWG. Contact Fulham for higher remoute distance.

Service life/Lifetime

- Failure Rate Info based upon MTBF modeling: 90% survivals at end of life @ $\leq T_c$ lifetime rating.

Warranty

- Reference Fulham's limited Warranty: <https://cdn.fulham.com/PDFs/Limited-Warranty.pdf>



IHCV-1UNV024V-100L



Part Number Matrix

IH CV 1 UNV 024V 100 L

LED Driver	Constant Voltage	# of Control Channels	Input Voltage	Output Voltage	Max. Output Power	Case Type
IH = IceHorse LED		1 = 1 Channels	UNV = 110V~277V	024V = 24V	100 = 100W	L = Long

Product Image: LED Driver

IHCV-1UNV024V-100L



Packaging

Master Carton

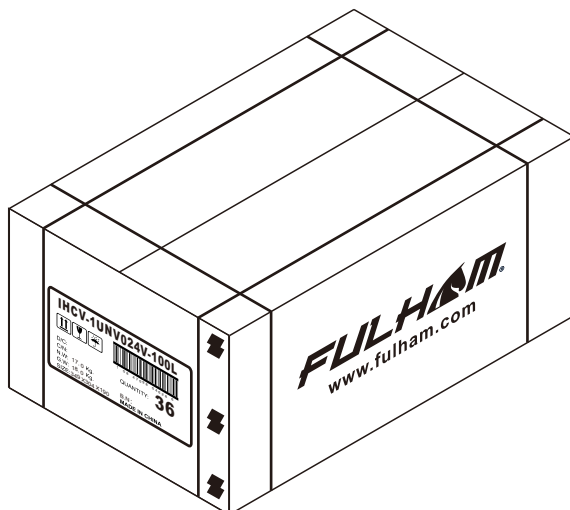

OUTER DIMENSION		
L	W	H
349mm(13.74")	304mm(11.97")	190mm(7.48")
Net Weight	Gross Weight	QUANTITY
17kg 37.48lb	18kg 39.68lb	36